

Building Distributor

1 General

Smallest splice/patch enclosure of the BUDI family using FIST with a maximum of 12 connections.

2 Kit content



3 Feeder cable installation

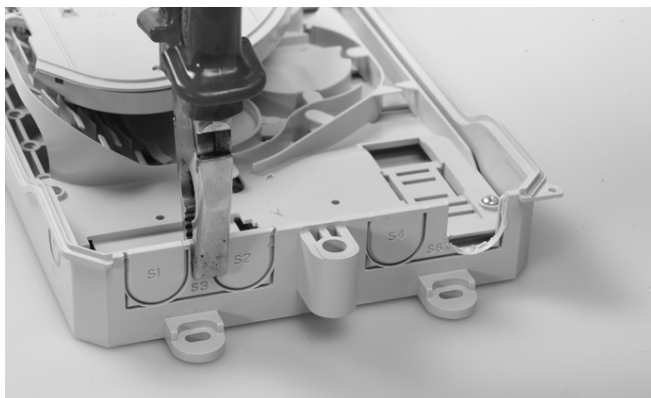

3.1 Open up feeder and drop cables entries.

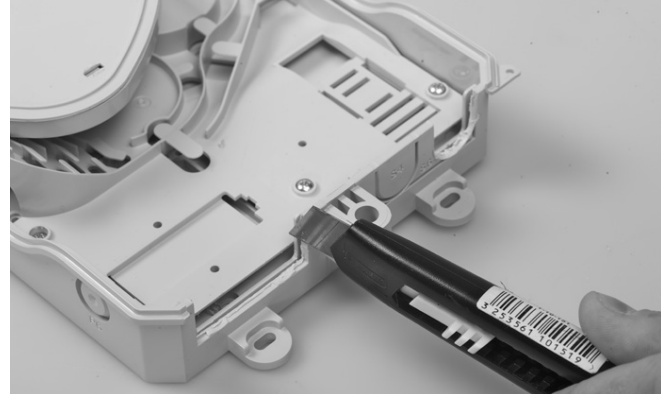

3.2 Remove all burrs and sharp edges from the cable entries with a sharp knife (e.g. carpet cutter).

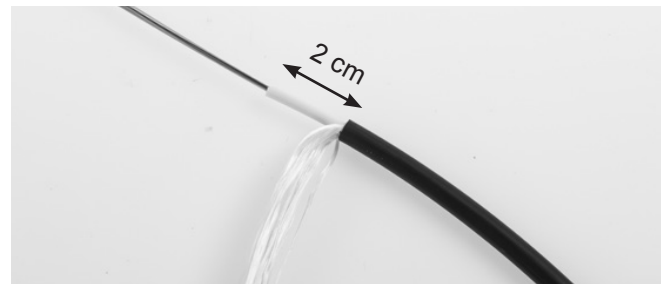

3.3 Strip the feeder cable (1,5 m) and strip the loose-tube leaving 2 cm of it.

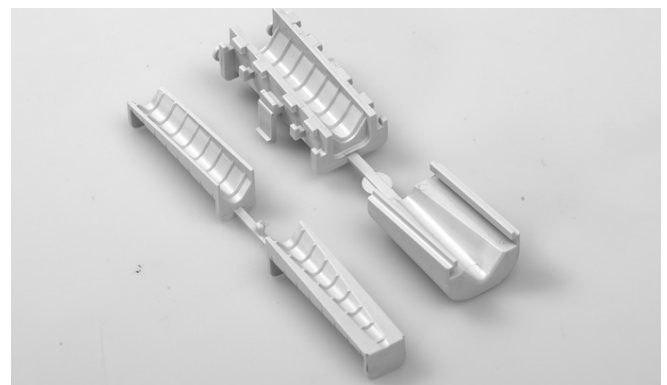

3.4 Break off the parts needed for feeder cable termination.

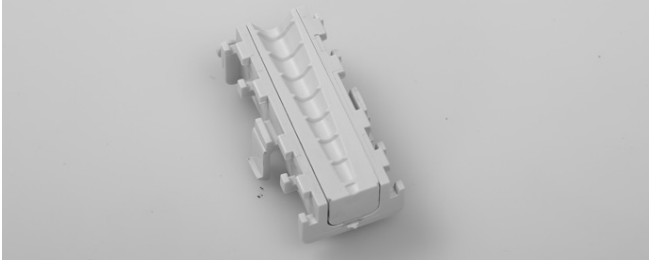

3.5 Install the insert into the cable holder depending on the cable diameter (2 inserts are available).

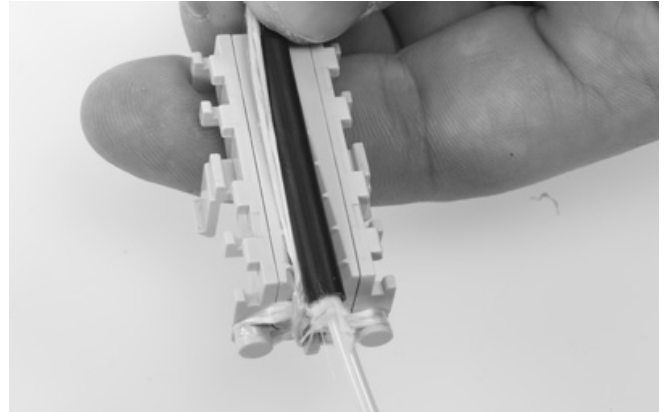
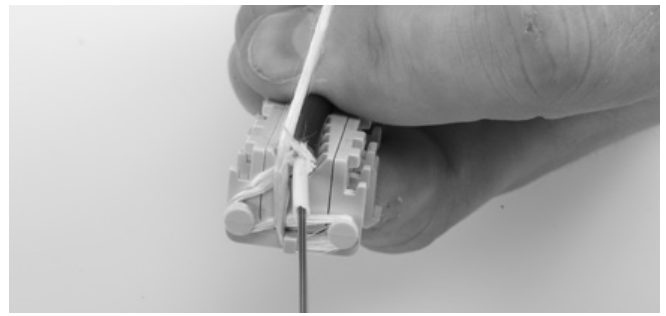

3.7 Route the aramid yarns around the lips as shown.

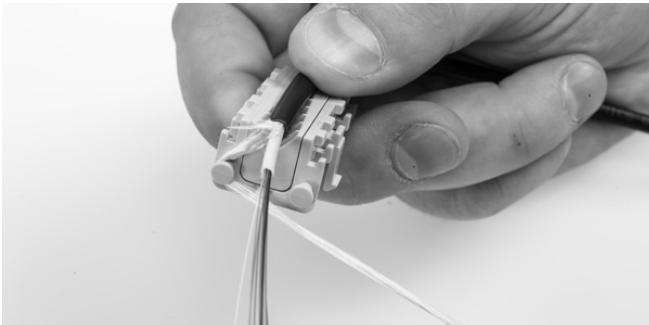

3.6 Install the feeder cable into the cable holder.

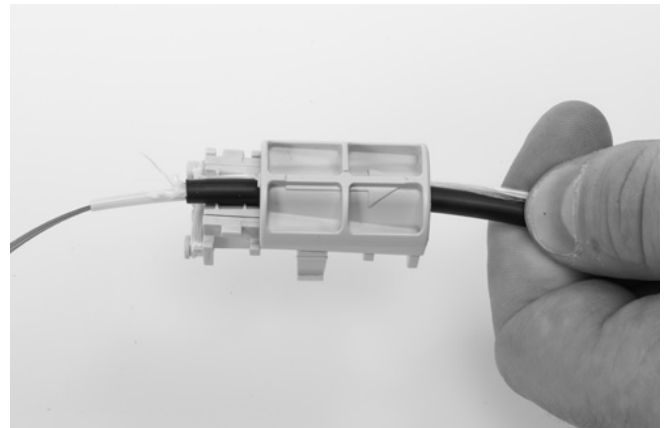
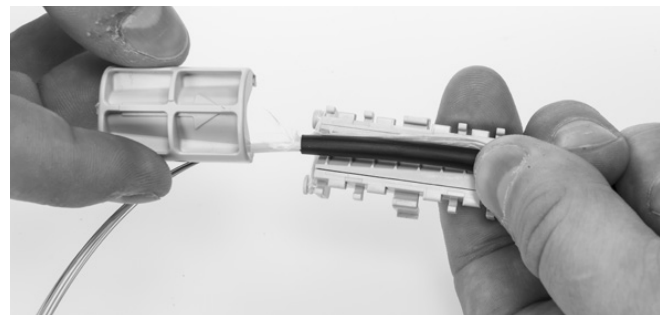

3.8 Close the cable holder by sliding the cover over the base (orientation arrow towards the cable) and cut of the rest of aramid yarns.

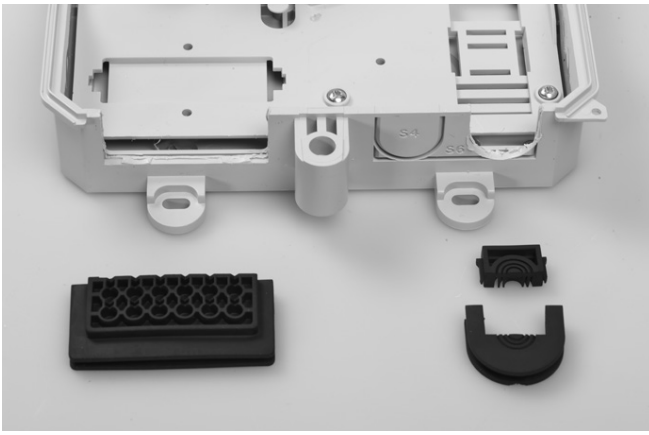

3.9 Install the grommets.

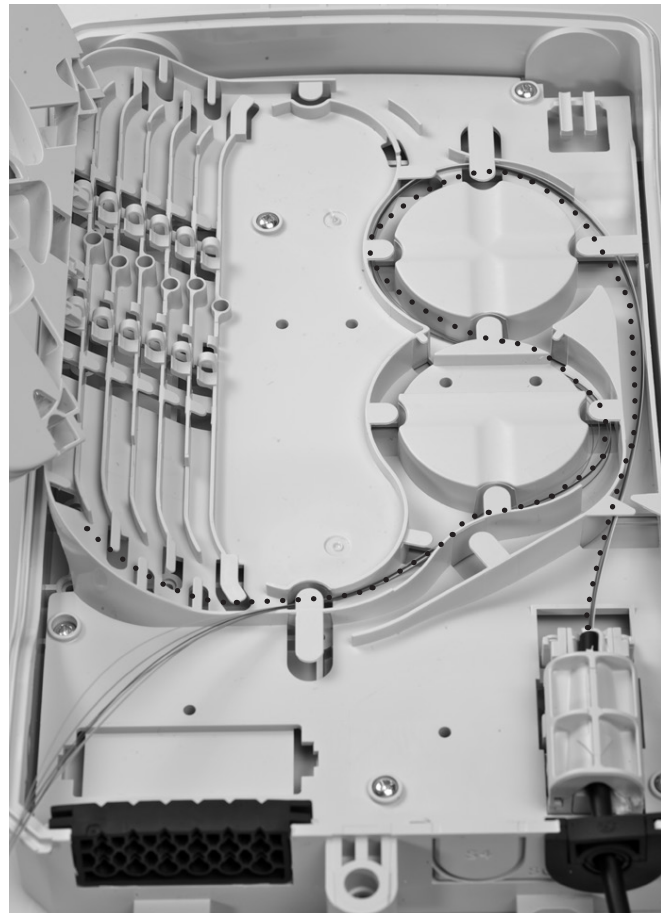

3.10 Install the cable holder into the box on the lowest position (adjust the position depending on the cable diameter).

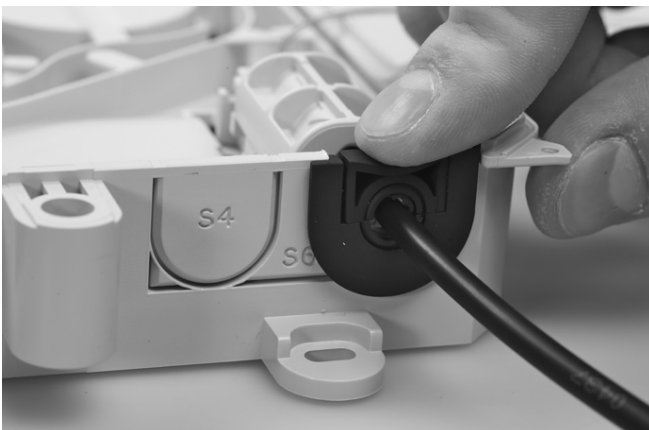

3.11 Install the second part of grommet to seal the box.



3.12. Route the fibers to be spliced towards to the tray through the Box as shown.

4 Patch panel installation

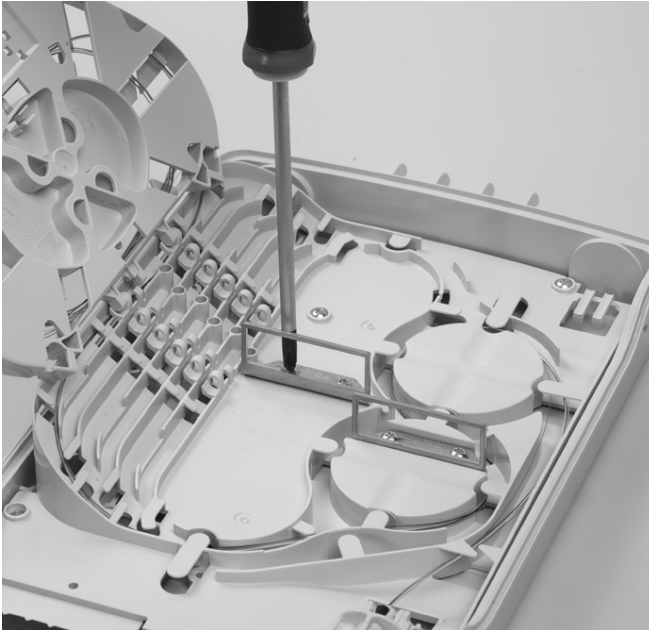

4.1 Install the patch panels.

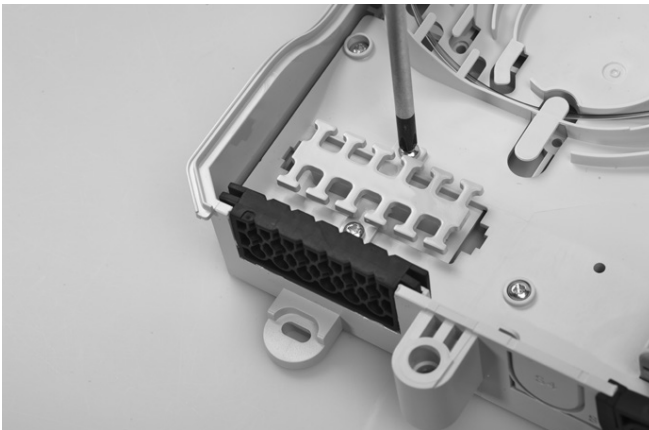

4.2 Install the strain relief for drop pigtails.

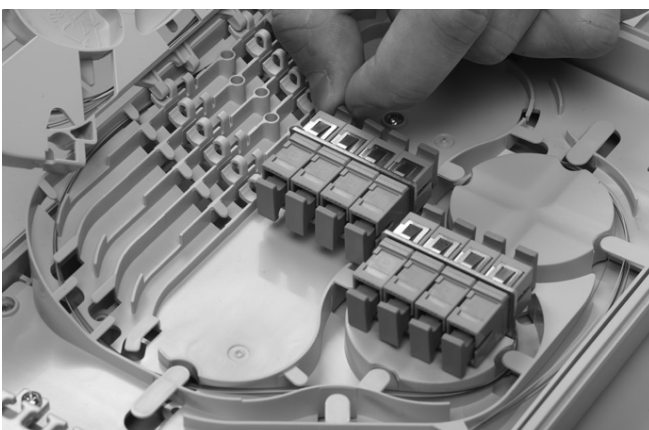

4.3 Insert the adapters and remove the plugs.

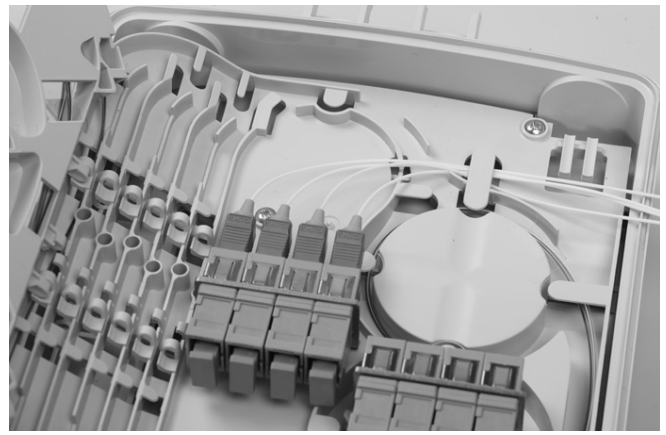

4.4 Connect first four 900µm pigtails.

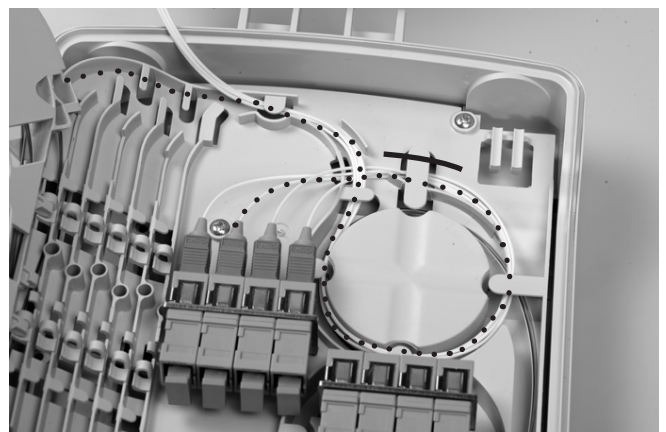

4.5 Route the first four 900µm pigtails to be spliced towards to the tray trough the Box as shown.

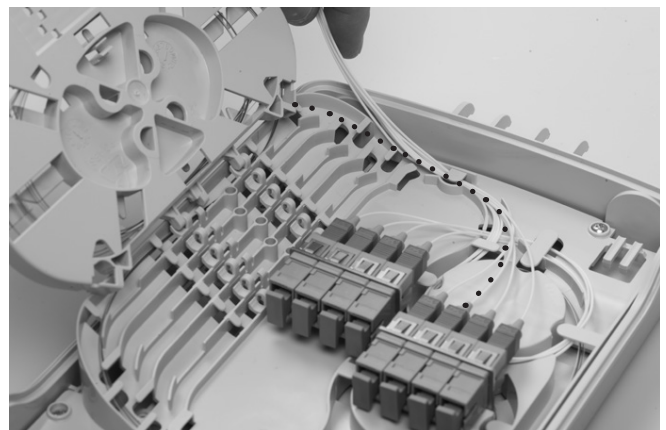

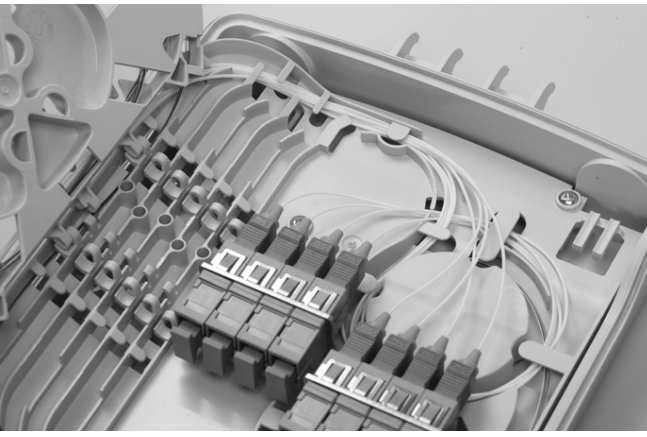

4.6 Connect the rest of the 900 μ m pigtails and route them towards to the tray trough the Box as shown.

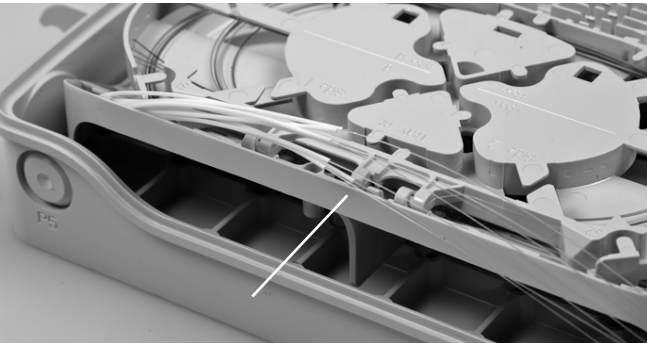

4.7 Strip the 900 μ m pigtails at the marked position.



4.8 Splice the fibers from the feeder cable to the pigtails and store the overlength into the tray.

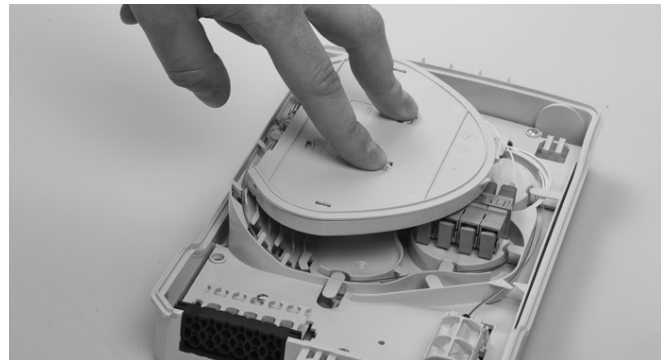

4.9 Install the cover onto the tray.

5 Drop cables installation

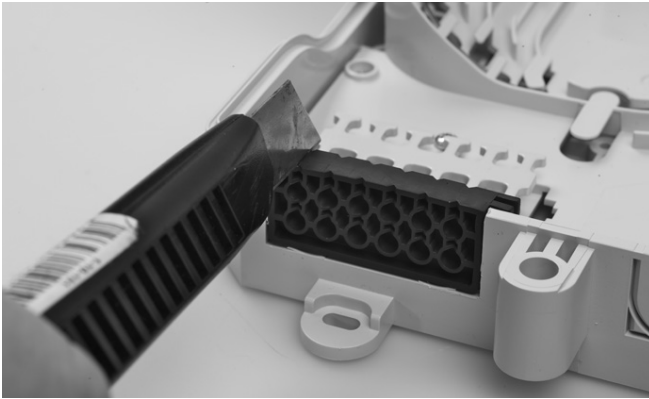

5.1 Cut the grommet where the drop cable will be installed.

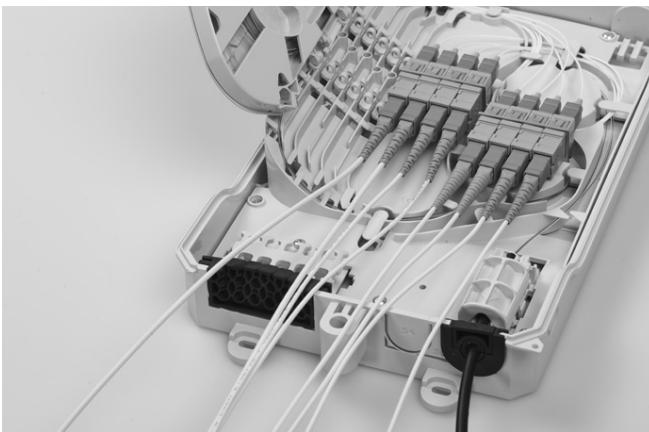

5.2 Connect all the drop cables.

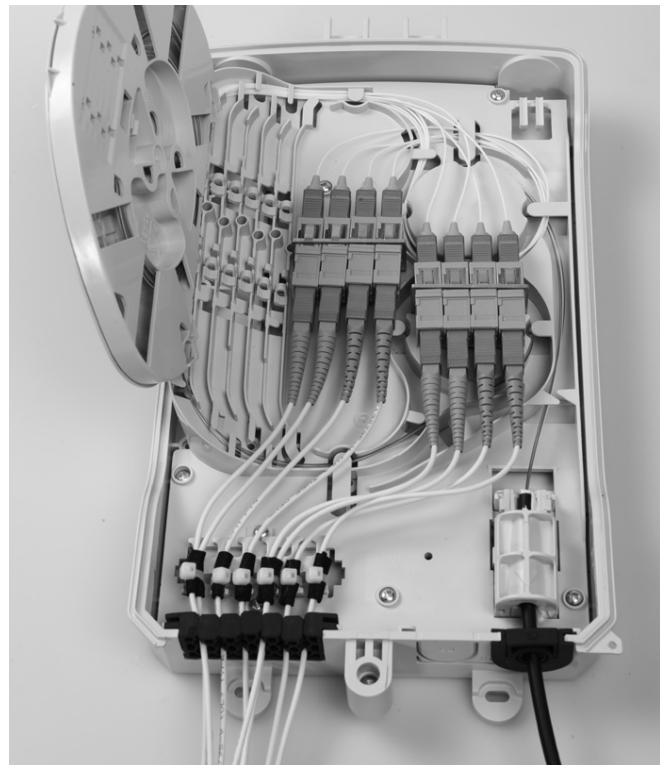
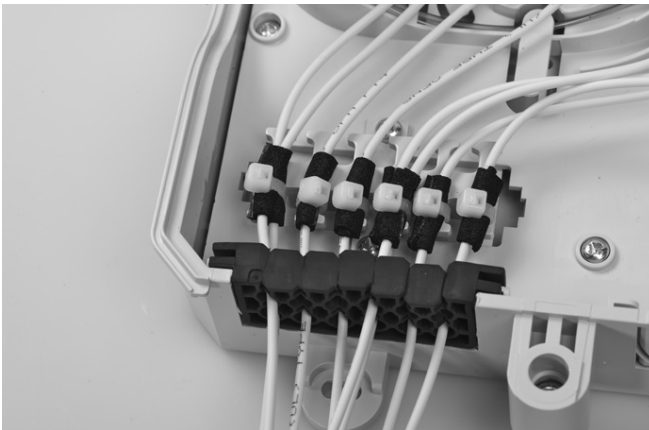

5.3 Apply the foam and secure with tie-wraps as shown.

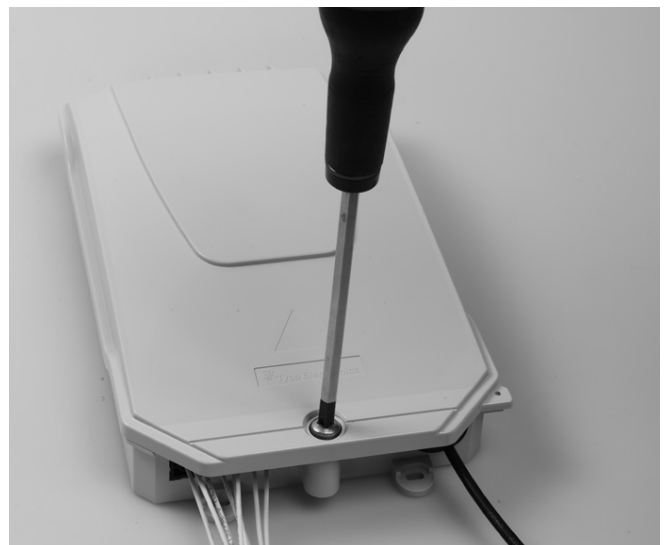

5.4 Install the cover and secure with the screw.



5.5 Installed box.

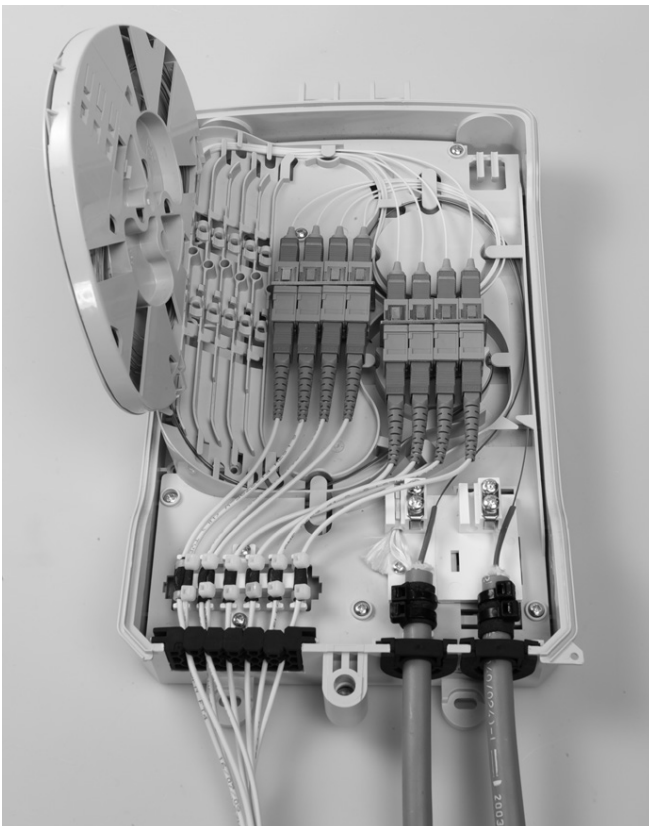

5.6 Installed box with two feeder cables (optional).

Tyco Electronics Raychem bvba

Diestsesteenweg 692
B-3010 Kessel-Lo, Belgium
Tel.: 32-16-351 011
Fax: 32-16-351 697
www.te.com
www.telecomnetworks.com

FIST, TE Connectivity and TE connectivity (logo) are trademarks of the TE Connectivity Ltd. family of companies.

While TE Connectivity and its affiliates referenced herein have made every reasonable effort to ensure the accuracy of the information contained in this catalog, TE Connectivity cannot assure that this information is error free. For this reason, TE Connectivity does not make any representation or offer any guarantee that such information is accurate, correct, reliable or current. TE Connectivity reserves the right to make any adjustments to the information at any time. TE Connectivity expressly disclaims any implied warranty regarding the information contained herein, including, but not limited to, the implied warranties of merchantability or fitness for a particular purpose. TE Connectivity' only obligations are those stated in TE Connectivity' Standard Terms and Conditions of Sale. TE Connectivity will in no case be liable for any incidental, indirect or consequential damages arising from or in connection with, including, but not limited to, the sale, resale, use or misuse of its products. Users should rely on their own judgment to evaluate the suitability of a product for a certain purpose and test each product for its intended application.